

# Vacuum Mixers

## Wamix-Touch

## Wamix-Touch Injector



171970  
Wamix-Touch



171971  
Wamix-Touch Injector



USER MANUAL

**Dear customer,**

Thank you for choosing a product from the Wassermann range. Wassermann Dental-Maschinen incorporates the highest standards of quality and the latest technology. In order to enjoy maximum performance and years of trouble-free operation, please read this user manual carefully before you connect this device and start work, and operate the device according to the recommended guidelines. The operation safety and the functionality of this device can only be guaranteed if you follow both the general safety guidelines and the applying laws to prevent accidents as well as the precautions given in this user manual. We are not liable for any damages which occur due to inappropriate usage or faulty operation of this device.



Make sure that anyone using this device has read and understood this user manual.

Keep this user manual in a safe place where it can be referred to as required at any time.



The unit complies with the relevant EU guidelines.



The unit is subject to the EU guidelines 2012/19/EU (WEEE Directive).

**Company address:**

Wassermann Dental-Maschinen GmbH

Rudorffweg 15-17

21031 Hamburg, Germany

Phone : +49 (0)40 730 926 -20/ -24 Fax.: +49 (0)40 730 37 24

[export@wassermann-dental.com](mailto:export@wassermann-dental.com)

[www.wassermann.hamburg](http://www.wassermann.hamburg)

[www.facebook.com/WassermannDentalmaschinen](https://www.facebook.com/WassermannDentalmaschinen)

## Contents

1 Features.....	4
2 Safety Symbols used in this Manual.....	5
3 Safety Guidelines.....	5
4 Responsibility for Operation or Damage.....	6
4.1 Warranty.....	6
5 Application.....	7
6 Before Starting.....	7
6.1 Storage.....	7
6.2 Transport.....	7
6.3 Installation.....	8
6.4 Wall Mounting.....	8
6.4.1 Mounting Instruction Fastening Set for Wall Mounting.....	9
7 Installation/ Start-up.....	12
7.1 Before Starting the Unit, Connect Up the Following:.....	12
7.1.1 Compressed Air Supply Wamix-Touch Injector (Item No. 171971).....	12
7.2 Start-up.....	12
7.2.1 Only for Wamix-Touch Injector version:.....	13
8 Operation.....	15
8.1 General Operating Instructions.....	15
8.2 Main menu.....	16
8.3 Program menu.....	16
8.3.1 Program name.....	16
8.3.2 Program parameter (vacuum time).....	17
8.3.3 Program parameter (speed).....	17
8.3.4 Program parameter (vacuum).....	17
8.3.5 Das Setupmenü.....	18
8.3.6 time and date.....	18
8.3.7 Information.....	18
8.3.8 Starting parameter.....	19
8.3.9 Pre-mixing parameter.....	19
8.4 Program procedure.....	20
8.4.1 Example of a program procedure.....	20
8.4.2 Important informationen.....	21
9 Troubleshooting.....	22
10 Care and Maintenance.....	24
10.1 Cleaning.....	24
10.2 Maintenance.....	25
10.2.1 Changing the Filter.....	25
10.3 Scope of Delivery/ Accessories.....	26
10.4 Repairs.....	27
10.5 Spare Parts.....	27
11 Technical Data.....	28
12 Disposing of the Unit.....	29
12.1 Information on Disposal for Countries within the EU.....	29
13 EU Declaration of Conformity.....	30

## 1 Features

The **Wamix-Touch/ Wamix-Touch Injector** units are modern vacuum mixers used not only for mixing all kinds of plasters, embedding media and silicones, but also designed for specialised dental procedures and for vacuum-rinsing of prostheses.

- Touch screen for fast and easy operation: Displays all parameters, various individual settings are possible
- Quick and reproducible processes: You can save 30 programs with your choice of names and access them at any time
- The vacuum and speed values set by the user are controlled by a microcontroller and are automatically readjusted
- Vacuum and speed monitoring guarantee homogeneous mixing of all kinds of plaster, embedding materials and silicones
- Inclined motor for easy insertion of the mixer beaker, comfortable single-hand operation, optimum mixing results
- Visual safety system (*Fig. 3*) helps to identify overfilling, additionally with protective filter against taking up liquids
- Automatic mixing when beaker is applied, programmable pre-mixing mode with right and left operation, adjustable change of rotation direction
- Visual and audible signal at programme end
- Beaker vented only after confirmation, post-vacuum also reduces gas inclusions
- High quality metal components, almost maintenance-free
- Simple cleaning due to stay-clean surfaces, plastic powder coated
- Can be installed flexibly as a wall or counter device, table stand available as extras
- **Wamix-Touch:** Depending on the application three vacuum levels are adjustable. Since it just requires a single power supply connection, the selection of the location is very flexible.
- **Wamix-Touch Injector:** Vacuum is achieved rapidly with this process even for large volumes, thus saving time. Compressed air supply is required.

## 2 Safety Symbols used in this Manual



### **Warning!**

This is a warning of risk situations and dangers.  
Failure to observe this warning could be life-threatening.  
These warnings has to be observed.



### **Information!**

This symbol draws your attention to specific features that has to be observed.

## 3 Safety Guidelines

Configuring and operating this equipment requires ***precise knowledge*** and ***observance*** of the instructions in this ***user manual***. The equipment is designed only for its intended application.



### **WARNING:**

Servicing and repairs should be carried out only by authorised specialists.  
Disconnect the power plug before starting any maintenance work.



The unit is designed to operate on 100-240 V / 50/60 Hz.  
Make sure that the equipment is connected to the correct power source.

**A safety angle underneath each unit prevents it coming loose once it has been mounted in the bracket.**

Allow the condensers to discharge before opening the unit.

## 4 Responsibility for Operation or Damage

The responsibility for operating the device lies exclusively with the owner or user if said device is incorrectly serviced, maintained or altered by persons not employed by an authorised dealer or if the device is used in a manner contrary to its specified purpose. The unit has to be maintained and operated in accordance with this user manual. Wassermann Dental-Maschinen GmbH is not responsible for damage arising from the **nonobservance** of these instructions.

Warranty and responsibility provisions contained in the sales and supply conditions of Wassermann Dental-Maschinen GmbH are not extended by these instructions.

### 4.1 Warranty



The warranty period for our equipment is 12 months. If faults occur within the warranty period, contact your dental depot or get in touch directly with our service department.

Your equipment should only be operated in perfect condition. If faults occur which could harm operators or third parties, the unit should not be used until it has been fixed.

This warranty does not cover damage caused by improper use, external mechanical causes, transport damage or interference with the unit by unauthorized persons.

## 5 Application

The **Wamix** units are used for mixing all kinds of plasters, embedding media and silicones under vacuum.

This units are also suitable for vacuum rinsing of models for special dental procedures.

The insulating layer between the model and the prosthesis cannot separate prematurely because the model remains moister in the pressure-embedding unit than when water is used.

Only use the device for this type of application.

## 6 Before Starting

### 6.1 Storage

The unit location is very important when it comes to workplace safety, even if it is only to be set up there for a short period. The room should be dry, well ventilated and vibration-free. An even temperature and wooden supports also help. The unit should not be stored or set up outdoors. If the unit is to be stored for an extended period, protect it from moisture and dust.

### 6.2 Transport

Before transporting the unit, ensure that it has been unplugged from the power socket. Make sure that it is packed correctly in order to avoid accidental damage.



Be sure to check for any transport damage when unpacking the goods. Note down any damage if found.

### 6.3 Installation

Open the box, remove the packing materials, and carefully lift out the device and accessories. Check the included accessories.

The **device with stand** has to stand horizontally on a steady and even surface.

### 6.4 Wall Mounting

**If mounting the unit on the wall**, make sure that the wall is strong enough to take the weight. Use the supplied bracket to mount it horizontally on the wall. For drawing a **drilling scheme** to drill the dowel holes please see page 9. Leave at least 30-35 cm free space beneath the unit.



Install the device in a place where it will not block the working area and the functionality (take the dimensions into account).



Do not install the unit outdoors or in places without proper ventilation.  
Before start-up, be sure the device reaches room temperature.



### 6.4.1 Mounting Instruction Fastening Set for Wall Mounting

Please check the included accessories:

Incl. in delivery item.-no. 174358 fastening set	
Quantity	Name
1	Safety angle
1	Phillips head screw M 4x8
1	Washer Ø 4,3
1	Serrated washer Ø 4,3
1	Slotted screw 4 x 16
2	Slotted screw 6 x 50
2	Screw anchor S8
1	Screw anchor S5

#### **Mounting Instruction:**

Please drill the holes as indicated in the following drilling template. Please make sure before that the wall is really suitable for mounting a device (aerated concrete walls and drywall are problematic).

#### **Drilling Template:**

Bohrung=drilling

tief=deep

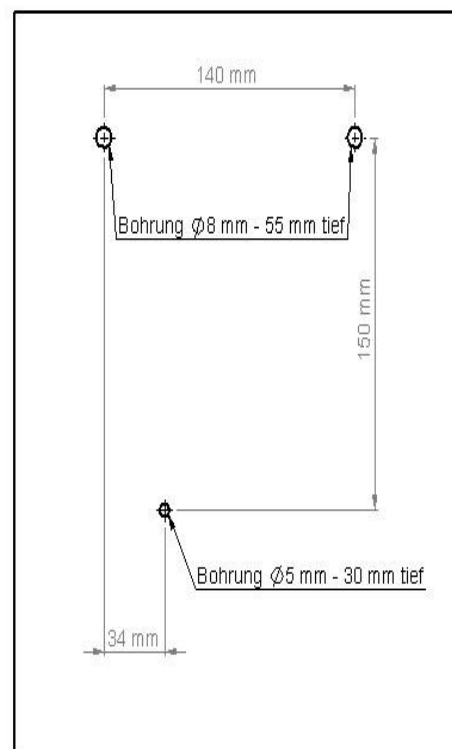

Secure the enclosed screw anchors as shown in *Figure 1*. Screw the 6x50 screws into the two upper holes; keep a distance of 6-7 mm to the wall! (*Figure 2*)

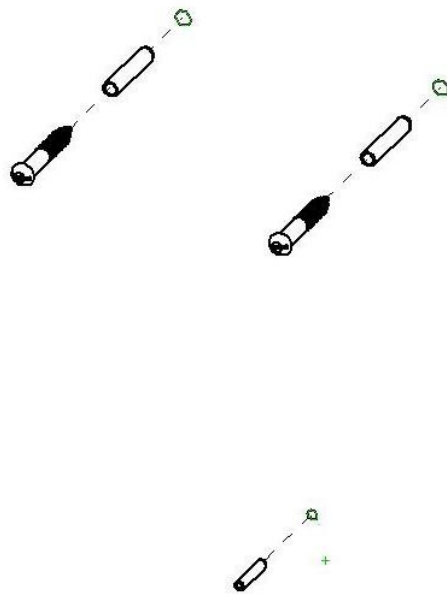

*Fig. 1*

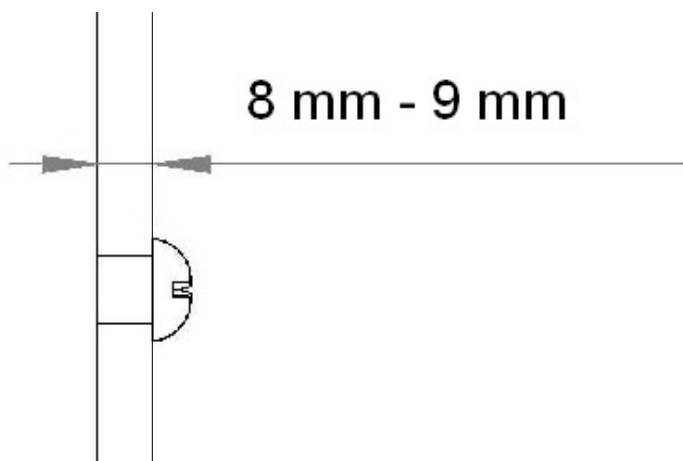

*Fig. 2*

Screw the safety angle to the **Wamix** as shown in *Figure 3*.

Do not yet fully tighten the Phillips head screw, however – you still need to be able to move the safety angle.

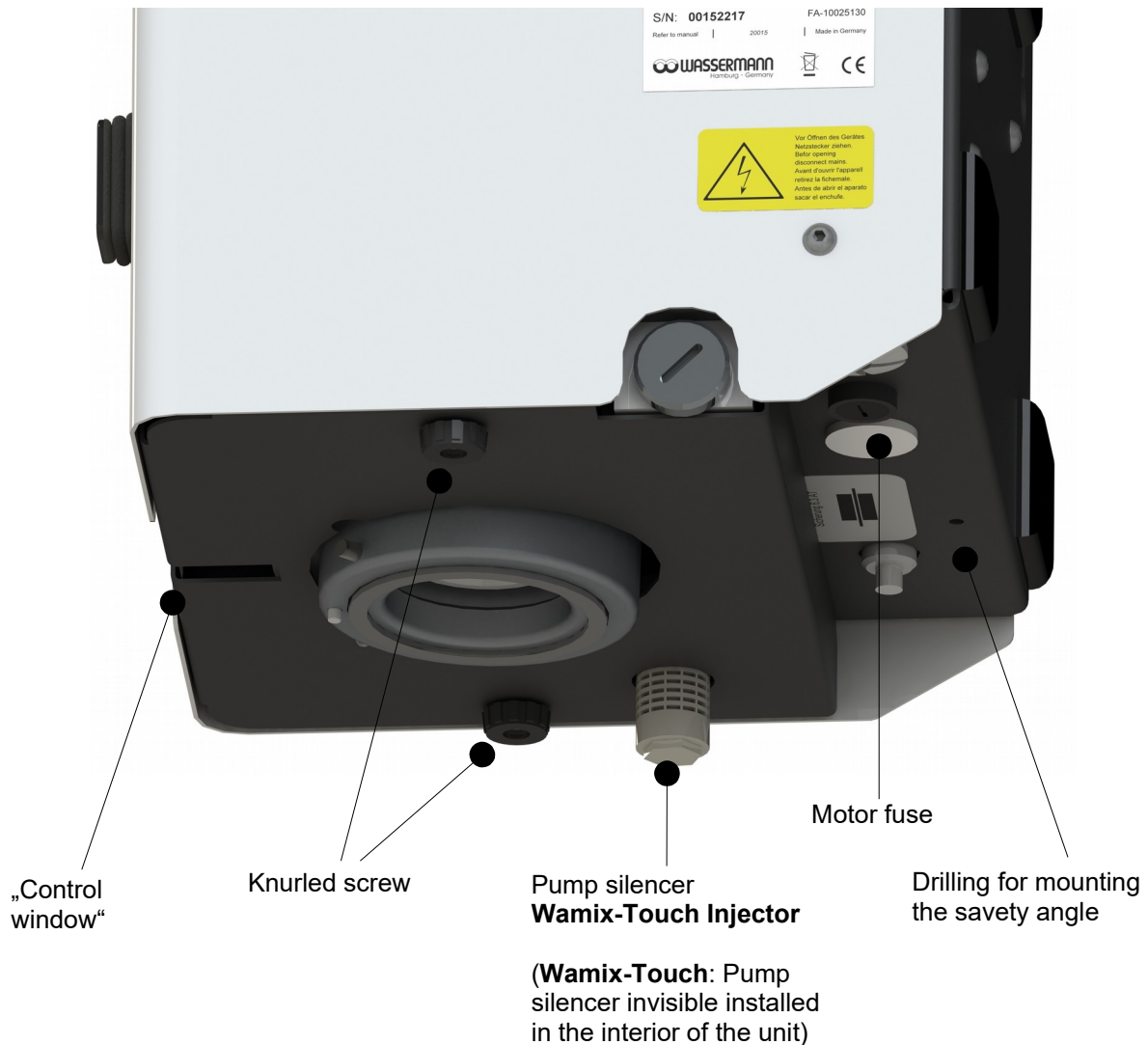

*Fig. 3*

Carefully hook in the device. Check, whether the device hangs loosely (i.e. moving back and forth on the screws). If this is the case tighten the 6x50 screws until the device hangs securely. Finally tighten the safety angle. First at the wall, then tighten the screw on the device itself (*Figure 3*).

## 7 Installation/ Start-up

### 7.1 Before Starting the Unit, Connect Up the Following:



Please check that the mains voltage and the voltage requirements of the mixer are the same, then plug in the power cable.

#### 7.1.1 Compressed Air Supply Wamix-Touch Injector (Item No. 171971)

Install a compressed air line in accordance with the technical data. Be sure to use the correct hose size if the line is long (inside diameter min. 6 mm). Provide a servicing unit for each line and use a pressure regulator to maintain a constant pressure.

### 7.2 Start-up

- Switch on the green mainswitch (*Fig. 4*).



*Fig 4*

### 7.2.1 Only for Wamix-Touch Injector version:

- Set up a compressed air supply.
- Start the mixing program. The pre-vacuum is built up and the bar graph of the pressure display moves from right to left.
- Optimal vacuum is achieved when the bar graph is to the left of the vertical line.
- Before the **first use** of the system, **it could be necessary to adjust the vacuum** with the **internal throttle** valve. For this remove the small plug on the bottom (Figure 5).

Pressure of the air supply should be 5 bar at least.

To adjust the valve please use a small screwdriver.

- For the adjustment of the vacuum start a mixing program with a long pre-vacuum time (e.g. 300 s).
- First set the minimum pressure by carefully turning the valve to the right. Then slowly open the valve again (to the left) until an optimal vacuum is reached.



**The Max. and Min. positions has to be considered, otherwise the valve will be destroyed.**

- **The best vacuum value ist not reached when the valve is completely open.** **It is necessary to adjust the valve as describes above.** Later you only have to readjust if the pressure conditions change.

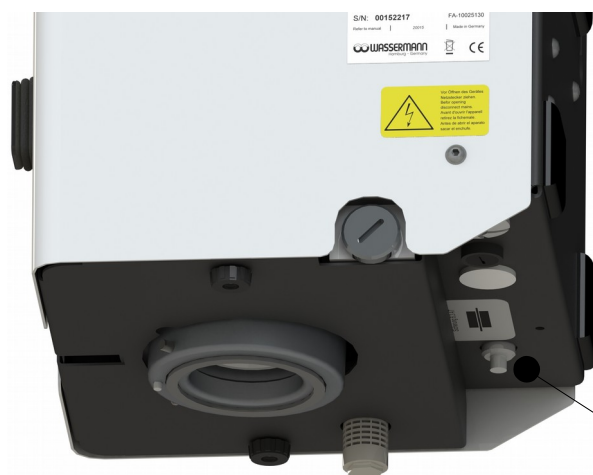

The throttle valve for the vacuum adjustment is on the bottom of the unit.

Fig. 5

 **Accidental mixing is not possible because the motor cannot start until the beaker is held to the rim by the vacuum.**

 **Please note that in the "low-vacuum" mode, depending on the filling quantity and cup size, the firm hold of the beaker by the vacuum is not guaranteed.**



**Before you start your vacuum mixer, make sure that the safety hook has been fastened under the unit. Push the hook to the wall using the slot and fasten the safety hook to the wall. Then retighten the screw on the chassis to prevent it coming loose.**



**Warning: Use only beakers with the new curved seal (171708).  
(For details please see 10.3 Accessories).**



If the unit will not be used for an extended period, switch off the vacuum mixer.

Also switch off the compressed- air supply (only **Wamix-Touch Injector**).

## 8 Operation



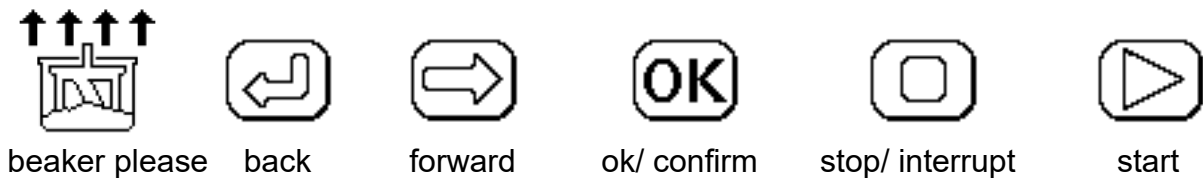

The touch screen allow the user to set all parameters quickly and easily using self-explanatory icons.

Important functions:



### 8.1 General Operating Instructions

All instructions for using the unit, whether in verbal or written form, are based on our own experience and experimentation and can only be regarded as guidelines.

- 
 Fill the beaker to the *Max marking*. Please pay special attention to the lower Max marking for Silicon. Otherwise the vacuum would draw any excess material into the system. Excess material would be appeared in the „control window“ (*Fig. 3*).
- 
 When mixing silicones, make sure that the beaker is **only filled to the max. height for silicone**. Otherwise, silicone could penetrate the interior of the unit itself.
- 
 The beaker will come away automatically once the vacuum is removed. To avoid damaging the seal, *never* remove the beaker by force.
- 
 The sealing surfaces between the beaker and the plate has to be clean - likewise the rotor fastenings and the beaker lid - to ensure trouble-free operation.

## 8.2 Main menu

description

WAMIX

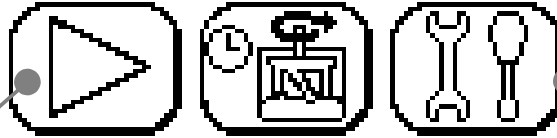

MO. 09. 01. 17 12:05:13

program start (quick-start)

8.3 program menu

8.3.5 setup menu

## 8.3 Program menu

8.3.1  
program name

8.3.2  
pre-vacuum time

8.3.2  
post-vacuum time

8.4  
program start

Prog.07



10 s

10 s

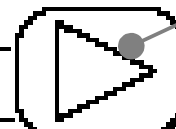

50 s

350RPM



7



8.3.4  
vacuum mode

8.3.2  
mixing time

program  
number

8.3.3.  
speed

back to  
main menu

### 8.3.1 Program name

You can type in names for each program. The default name is the program number.

WASSERMANN ■



back to program menu



### 8.3.2 Program parameter (vacuum time)

You can choose following parameters for each program:

vacuum value, pre-Vacuum time, mixing time, speed and post-vacuum time.

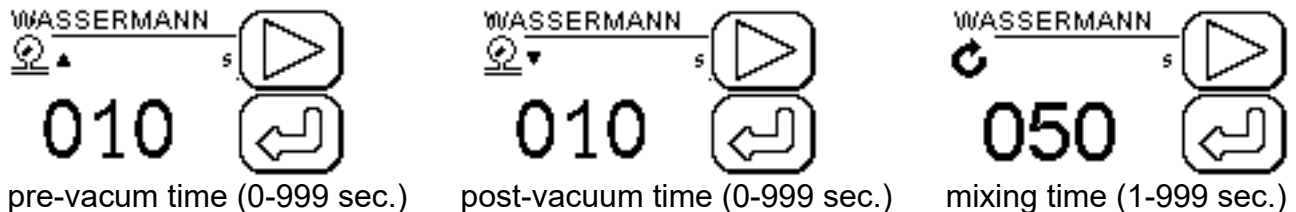

### 8.3.3 Program parameter (speed)

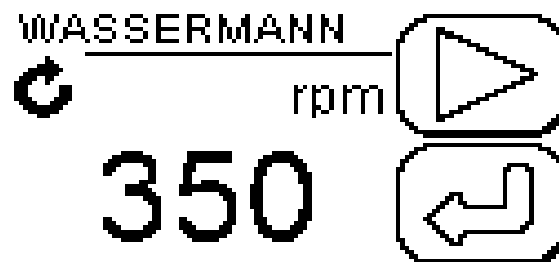

The mixing speed is adjustable in steps of 10 rpm from 100 rpm to 550 rpm.

### 8.3.4 Program parameter (vacuum)

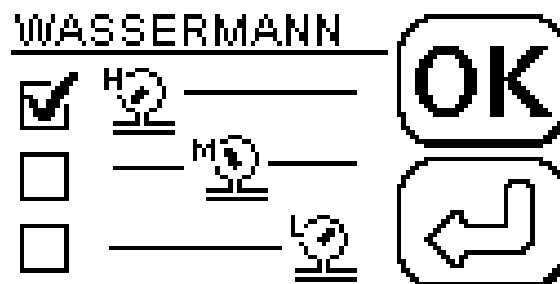

Three different vacuum values are available (only for **Wamix-Touch** pump version) :

H= high max. 120 mbar absolut, (**default value**), **pump in continuous operation**

M= medium approx. 200 mbar absolut (only for **Wamix-Touch** pump version)

L= low approx. 400 mbar absolut (only for **Wamix-Touch** pump version)

**The M and L vacuum mode are for special applications only!**

*Please run the **Wamix-Touch Injector** unit only in "L" vacuum mode! With a **Wamix-***

**Touch Injector** system you can change the vacuum level only with the throttle valve (not with the software vacuum modes).

### 8.3.5 Das Setupmenü

8.3.6 date and time

8.3.7 information

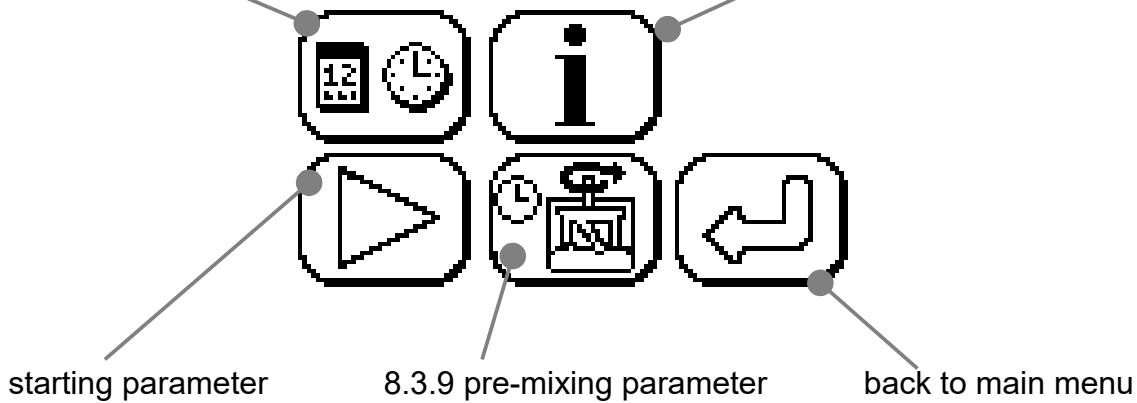

### 8.3.6 time and date

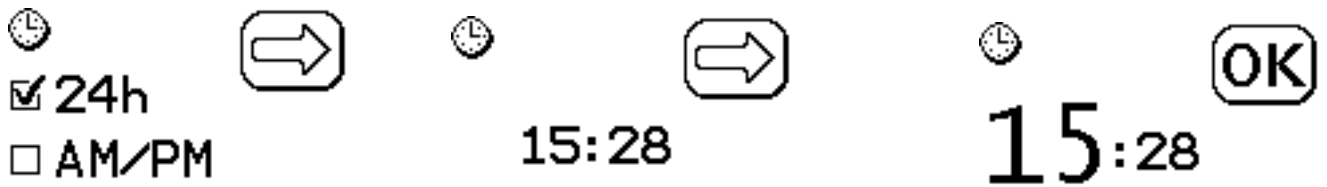

Adjust the date and time by pressing each digit.

### 8.3.7 Information

Information about the hardware, firmware and the controller

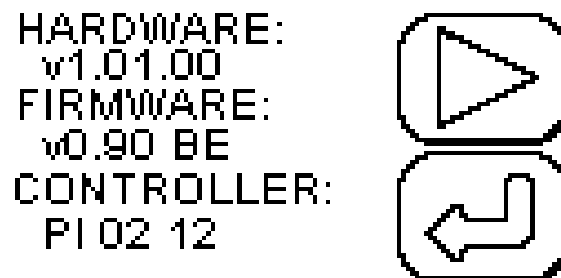

### 8.3.8 Starting parameter

The quick start function is configurable. The option “Last” will start the last mixing program you run and the “P.01” option will start the first program everytime you use the quick-start button. If the “Auto-start” function is enable the program starts directly when you put the beaker into the system without pressing any button.

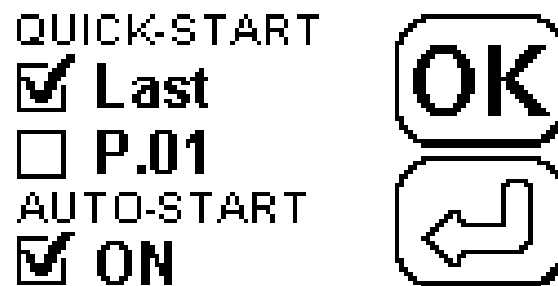

### 8.3.9 Pre-mixing parameter

If the pre-mixing function is active, the motor is changing the direction of the rotation.

You can choose the number of the pre-mixing intervals and the time.

The mixing speed is adjustable in percent. After the pre-mixing procedure the program will start.

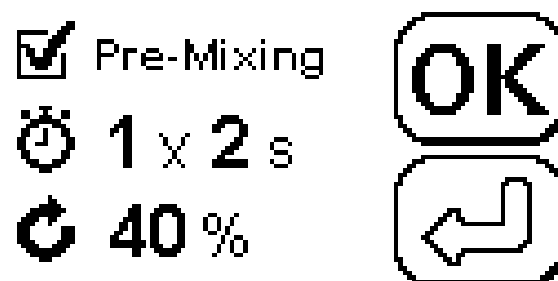

## 8.4 Program procedure

Display of the program procedure while running a program.

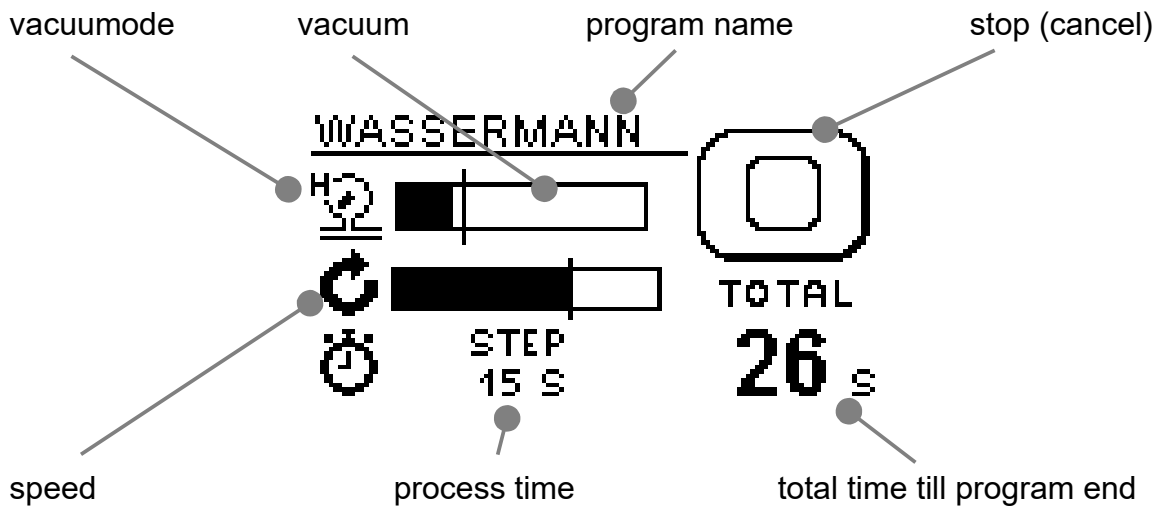

### 8.4.1 Example of a program procedure

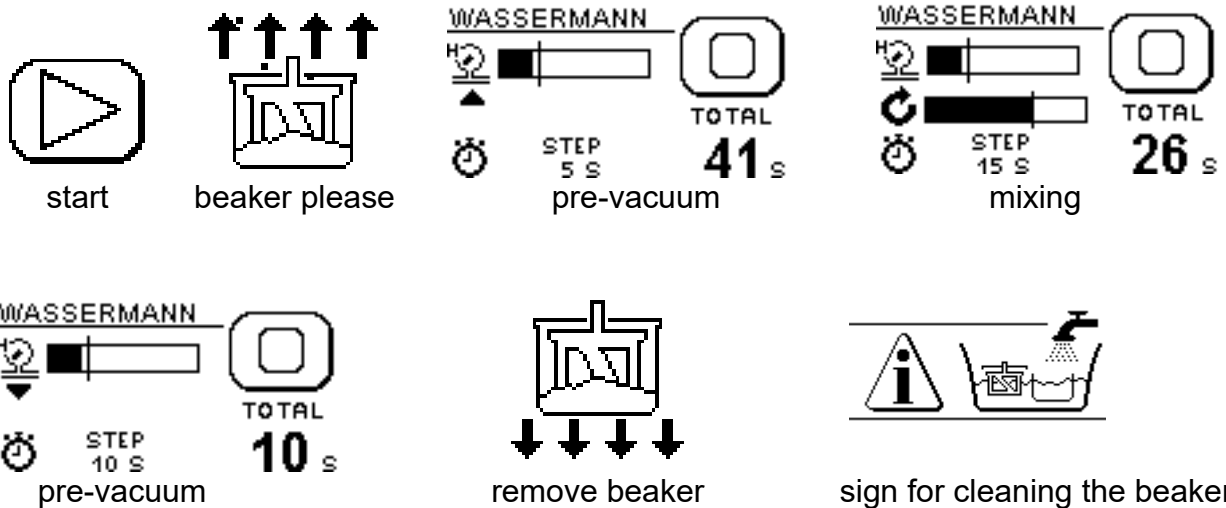

### 8.4.2 Important informationen

The display of the bar graph for the vacuum value is running from the right side (ambient pressure approx. 1013 mbar) to the left (max. 120 mbar (88 % Vakuum)).

- \* Depending on the location and weather the maximum vacuum value can vary.
- For best mixing results a pressure of 300 mbar or less should be reached.

#### Pumping process (begins after program start)

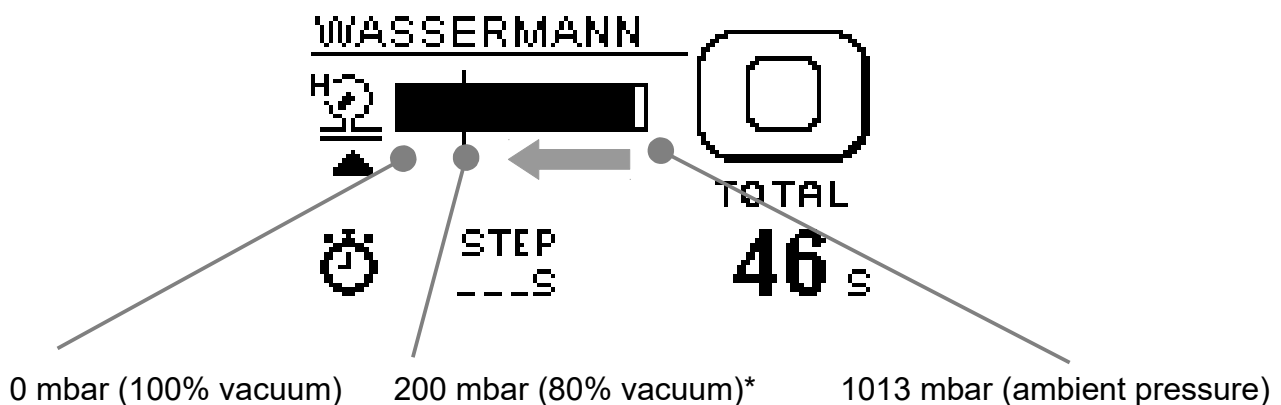

\* 200 mbar (vacuum = H) , 300 mbar (vacuum = M) oder (400 mbar vacuum = L)

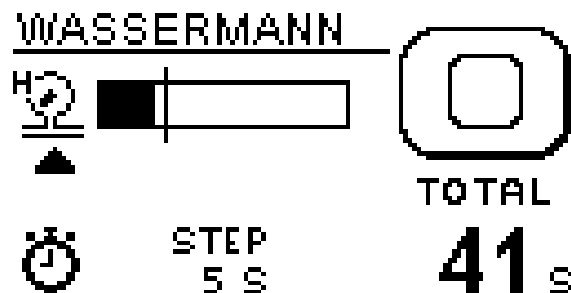

#### endvacuum is reached, pre-vacuum time begins



- If the end value of the pressure is not reached or the pressure increase while the program is running, a warning symbol is shown in the display and the program stops.



## 9 Troubleshooting

Fault	Cause	Remedy
Mixer does not start	Blown fuse	Replace fuse and determine cause; otherwise, call Service Center
	No mixing time programmed	Set mixing time
	No rpm programmed	Adjust the rpm
Vacuum too low	Filter (vacuum) blocked	Check filter – clean and/or change (see 10.2.1 Fig. 8)
	Dirty or leaking seal on vacuum flange for mixing beaker	Clean or replace seal
No vacuum	Beaker filled above <i>Max.</i> mark, i.e., mixing ingredients in system/"control window"	Clean system, i.e., maintenance by Service Center
	Only <b>Wamix-Touch</b> : Faulty vacuum pump	Maintenance by Service Center
Beaker falls out	Wrong coupling	Changing the coupling (171708)
 <p>Invalid program! Please check the time settings!</p>	Wrong program parameter	<p>Please check the mixing time of the program. The mixing time must be larger than 0s.</p>
<p>Prog.07</p>   <p>TIMEOUT</p>	Timeout warning. The vacuum value is not reached.	Please check the beaker and the beaker-sealing.

Fault	Cause	Remedy
Touchscreen malfunction	Calibrate the touch display	Switch on the unit. <u>While</u> the logo of Wassermann appears please contact the touch display two times. Then you will reach the self-explanatory touch panel-calibration (Fig. 6-7).
	Screen protector damaged?	Please contact our service.



Figure 6

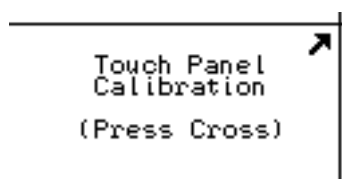

Figure 7



If the above recommendations do not solve the problem, contact your dental depot or our service department.

## 10 Care and Maintenance

### 10.1 Cleaning



Disconnect the power plug before starting any maintenance work.

The identification plate has always to be kept in easily legible condition and has not to be removed.



Remove external dirt from time to time with some form of cold cleaner.

Use only cold cleaners to avoid damaging the paintwork or removing the lettering.

The equipment should be cleaned at regular intervals to ensure trouble-free operation.

It requires only normal cleaning (sponge, damp cloth, mild detergent) and no further chemical additives.

Solvents ***must not*** be used to clean the front panel!

Keep the beaker clean. When not in use, fill with water to just below the mixer.

**Cleaning mixing beakers in an ultrasonic bath, especially if plaster solvents are also used in the beaker, will inevitably result in changes to the structure of the beaker material and will therefore damage the mixing beaker.**



## 10.2 Maintenance



**Disconnect the power plug before you open the unit.**

**Allow the condensers to discharge before opening the unit.**

Our vacuum mixers do not require much servicing. Make sure the unit is kept clean and that the rim seal for the beaker (vacuum seal) is not damaged.

### 10.2.1 Changing the Filter



*Fig. 8*

Remove screw (1). The filter swings loose at the forward end of the screw. After changing the filter, do up the screw finger-tight (do not forget the O-ring) (*Fig. 8*).

### 10.3 Scope of Delivery/ Accessories

Item no. 171970 **Wamix-Touch**

Item no. 171971 **Wamix-Touch Injector**

Included in delivery:

- **Beaker, medium cpl. 350 ml**
- **Mounting set for wall fastening**
- **Compressed air hose, 2 m Wamix-Touch Injector**

The **Wamix** units are delivered as wall models but are convertible as counter devices at any time. A table stand is available as extra.

#### **Accessories**

#### **Item no.:**

Table stand (W 208 x H 450 x D 275 mm)	171744
Beaker, extra small cpl. 75 ml	171295
Beaker, small cpl. 200 ml	171230
Beaker, medium cpl. 350 ml	171283
Beaker, large cpl. 600 ml	171237
Beaker, extra large cpl. 1000 ml	171269
Vacuum washing beaker, 600 ml	171275
Compressed air hose per meter <b>Wamix-Touch Injector</b>	320026

## 10.4 Repairs



Servicing or repairs to the unit has only to be carried out by qualified technicians. Only original spare parts are to be used. Responsibility for the product is voided if unauthorised persons alter it or if inappropriate components are installed.

## 10.5 Spare Parts

If necessary please contact our service hotline phone.

**Service Hotline 0049 (0)40 730 926 -20/ -24**

## 11 Technical Data

Item no. 171970 **Wamix-Touch**

Item no. 171971 **Wamix-Touch Injector**

Voltage	220–240 V / 50/60 Hz
Power consumption max. <b>Wamix-Touch</b>	2.5 A (Si 4.0 A)
Power consumption max <b>Wamix-Touch Injector</b>	1.8 A (Si 4.0 A)
Output <b>Wamix-Touch</b>	200 W
Output <b>Wamix-Touch Injector</b>	120 W
Speed (Motor control with intelligent regulation)	100 - 550 min <sup>-1</sup>
Vacuum* <b>Wamix-Touch</b>	approx. 120 mbar (absolute)
Vacuum* <b>Wamix-Touch Injector</b>	approx. 100 mbar (absolute)
Mixing time	999 sec. adjustable
W x H x D	195 x 310 x 180 mm
Weight <b>Wamix-Touch</b>	9.3 kg
Weight <b>Wamix-Touch Injector</b>	7.5 kg
Sound level	≤ 80 dB (A)
Safety class	IP 22
Compressed air connection <b>Wamix-Touch Injector</b>	min. 5 bar



Technical changes reserved.

\* „Vacuum means the state of a gas when in a container the pressure of the gas and thus the particle number density is lower than outside or when the pressure of the gas is lower than 300 mbar ( smaller than the lowest atmospheric pressure occurring on the earth's surface).

## 12 Disposing of the Unit

The unit has to be disposed by an authorized recycling operation. The selected company has to be informed of all possibly health-hazardous residues in the unit.

### 12.1 Information on Disposal for Countries within the EU



To conserve and protect the environment, prevent environmental pollution and improve the recycling of raw materials, the European Commission adopted a directive that requires the manufacturer to accept the return of electrical and electronic units for proper disposal or recycling.

Within the European Union units with this symbol should not therefore be disposed of in unsorted domestic waste.

For more information regarding proper disposal please apply at your local authority.

**13 EU Declaration of Conformity**

in accordance with 2014/35/EU (Low Voltage Directive) and 2014/30/EU (Electromagnetic Compatibility Directive) and 2006/42/EC (Machinery Directive) and 2011/65/EU (RoHS Directive)

Manufacturer: **W A S S E R M A N N**      Product description: Vacuum Mixers  
Dental-Maschinen GmbH      for dental  
Rudorffweg 15-17      applications  
21031 Hamburg  
Germany

Model: Wamix-Touch      Item no. 171970  
Wamix-Touch Injector      Item no. 171971

Applicable standards: DIN EN 61010-1  
DIN EN 61000-6-3  
DIN EN 61000-6-1  
DIN 45635-1  
DIN EN 60335-1

Hiermit wird bestätigt, dass die oben bezeichnete Maschine den genannten EU-Richtlinien entspricht. Diese Erklärung wird ungültig, falls die Maschine ohne unsere Zustimmung verändert wird.

This is to confirm that the above mentioned machine complies with the described EU guidelines. This declaration becomes invalid if the machine is modified without our approval.

Cette machine est conforme aux normes en vigueur d'Union européenne. Cet avis est nul et non avenant si cette machine est modifiée sans notre accord.

Esta máquina, anteriormente mencionada, cumple con los límites requeridos por el reglamento UE. Ahora bien, esta declaración quedará invalidada en caso de realizar modificaciones al aparato sin nuestra aprobación.

Hiermee wordt bevestigd dat bovengenoemde machine voldoet aan de voorgeschreven EU normen. Deze verklaring verliest geldigheid als er zonder onze uitdrukkelijke toestemming wijzigen aan de machine worden aangebracht.

Place, date: Hamburg, 2021-03-19

Company stamp :



Signature: \_\_\_\_\_  
Sven Wassermann  
(Managing Director)



**WASSERMANN**  
DENTAL-MASCHINEN GMBH  
Rudorffweg 15-17 · 21031 Hamburg

Notes:



Wassermann Dental-Maschinen GmbH  
Rudorffweg 15–17 · 21031 Hamburg · Germany  
Phone: +49 (0)40 730 926-20/ -24 · Fax: +49 (0)40 730 37 24  
export@wassermann-dental.com · www.wassermann.hamburg



/WassermannDentalmaschinen